



US00D428830S

# United States Patent [19] Brummer

[11] **Patent Number: Des. 428,830**  
[45] **Date of Patent: \*\* Aug. 1, 2000**

- [54] **RECUMBENT BICYCLE FRAME**
- [76] Inventor: **Timothy E. Brummer**, 1308 W. Willow, Lompoc, Calif. 93436
- [\*\*] Term: **14 Years**
- [21] Appl. No.: **29/096,450**
- [22] Filed: **Nov. 12, 1998**
- [51] **LOC (7) Cl.** ..... **12-11**
- [52] **U.S. Cl.** ..... **D12/111**
- [58] **Field of Search** ..... D12/111; 280/228.1-228.3, 280/281.1; 228/173.4

### [56] **References Cited**

#### U.S. PATENT DOCUMENTS

D. 301,136	5/1989	Brummer	.....	D12/111
D. 304,319	10/1989	Brummer	.....	D12/111
D. 327,040	6/1992	Brummer	.....	D12/111
D. 369,574	5/1996	Clarke	.....	D12/111
D. 420,370	2/2000	Spriggs et al.	.....	D12/111
5,272,928	12/1993	Young	.....	280/288.2

#### OTHER PUBLICATIONS

Brochure from Advanced Transportation Products, Inc., Model R40 (Sep. 1998).  
 RCN (Recumbent Bicycle News), Mar. 1997, Greenspeed GBR20/26 Tourer SWB.  
 Photocopy of photograph of an old Vision model from 1992 to 1993.

*Primary Examiner*—Melody N. Brown  
*Attorney, Agent, or Firm*—Christie, Parker & Hale, LLP

### [57] **CLAIM**

The ornamental designs for the recumbent bicycle frame, as shown and described.

### **DESCRIPTION**

FIG. 1 is a side elevation of a first embodiment of a recumbent bicycle frame showing my invention, the opposite side being a mirror image of that shown;  
 FIG. 2 is a top plan view thereof;

FIG. 3 is a front elevation view thereof;  
 FIG. 4 is a rear elevation view thereof; and,  
 FIG. 5 is a bottom plan view thereof.  
 FIG. 6 is a side elevation view, showing a second embodiment of a recumbent bicycle frame of my invention, wherein an adjustable portion of the frame is shown in its forward most position, the opposite side being a mirror image of that shown;  
 FIG. 7 is a top plan view thereof;  
 FIG. 8 is a bottom plan view thereof, and the front and rear of the second embodiment being represented by FIG. 3 and FIG. 4.  
 FIG. 9 is a side elevation view of a recumbent bicycle frame showing a third embodiment of my invention, the opposite side being a mirror image of that shown;  
 FIG. 10 is a top plan view thereof;  
 FIG. 11 is a bottom plan view thereof;  
 FIG. 12 is a front elevation view thereof; and  
 FIG. 13 is a rear elevation view thereof.  
 FIG. 14 is a side elevation view, showing a fourth embodiment of a recumbent bicycle frame of my invention, wherein an adjustable portion of the frame is shown in its forward most position, the opposite side being a mirror image of that shown;  
 FIG. 15 is a top plan view thereof;  
 FIG. 16 is a bottom plan view thereof; and the front and rear of this embodiment are represented by FIG. 12 and FIG. 13.  
 FIG. 17 is a side elevation view of a recumbent bicycle frame showing a fifth embodiment of my new design, the opposite side being a mirror image of that shown;  
 FIG. 18 is a top plan view thereof;  
 FIG. 19 is a bottom plan view thereof;  
 FIG. 20 is a front elevation view thereof; and  
 FIG. 21 is a rear elevation view thereof.  
 FIG. 22 is a side elevation view, showing a sixth embodiment of the recumbent bicycle frame of my invention, wherein an adjustable portion of the frame is shown in its forward most position, the opposite side being a mirror image of that shown;  
 FIG. 23 is a top plan view thereof; and,  
 FIG. 24 is a bottom plan view thereof; and the front and rear of this embodiment being represented by FIG. 20 and FIG. 21.

**1 Claim, 21 Drawing Sheets**

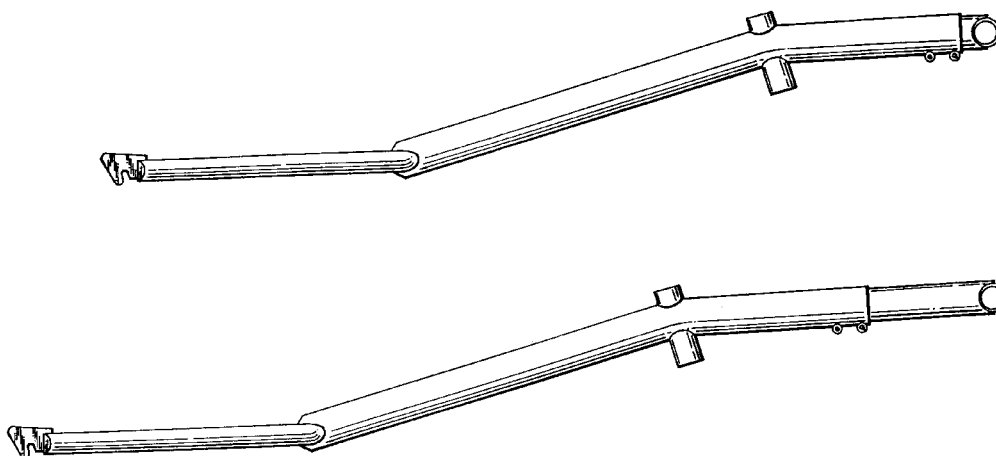

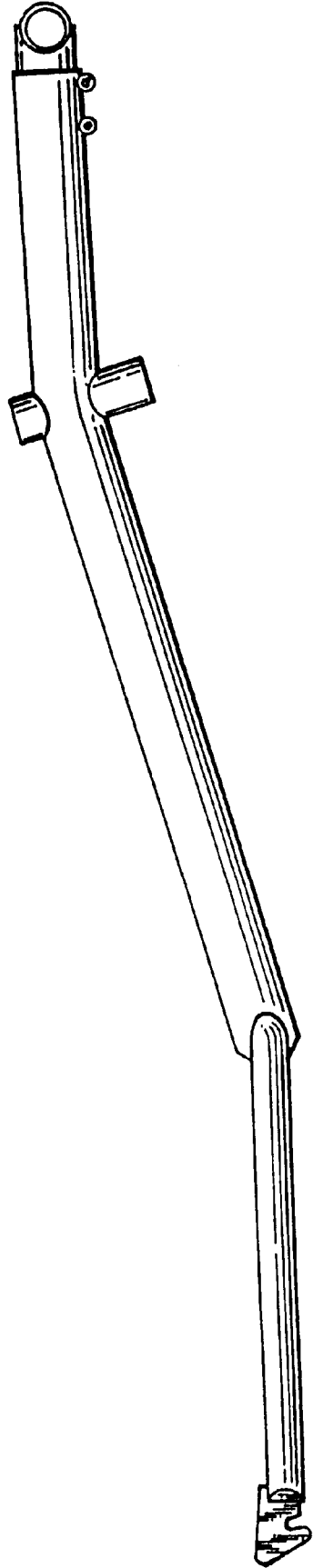

FIG. 1

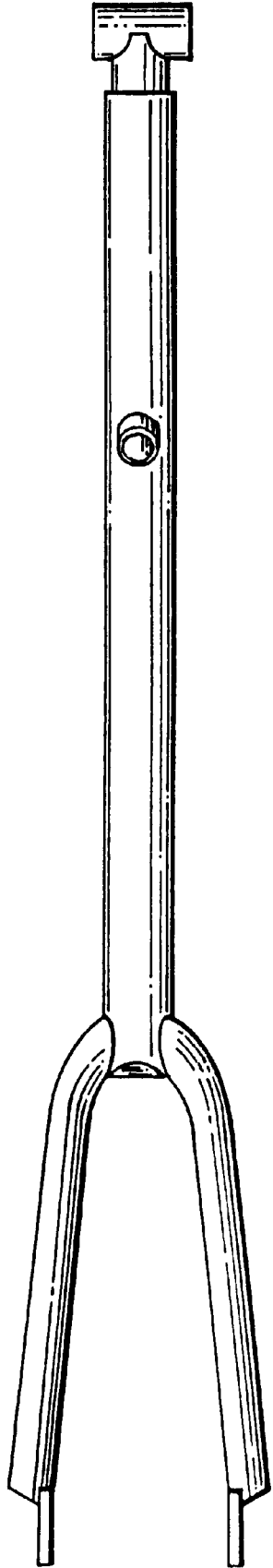

FIG. 2

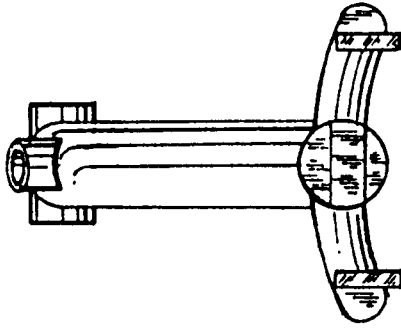

FIG. 4

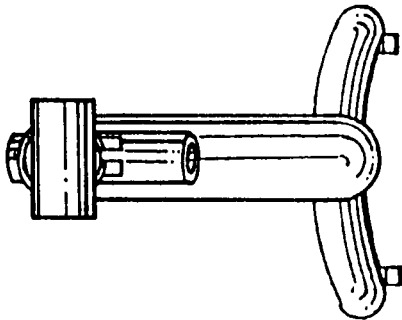

FIG. 3

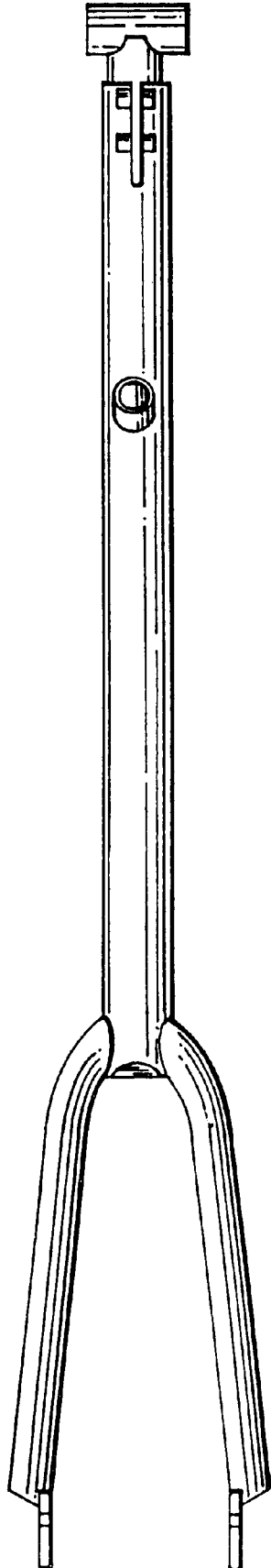

FIG. 5

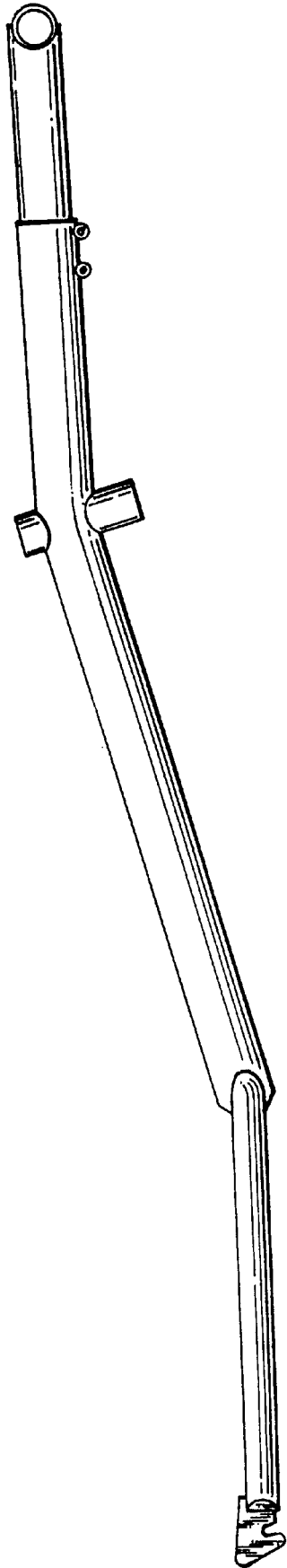

FIG. 6

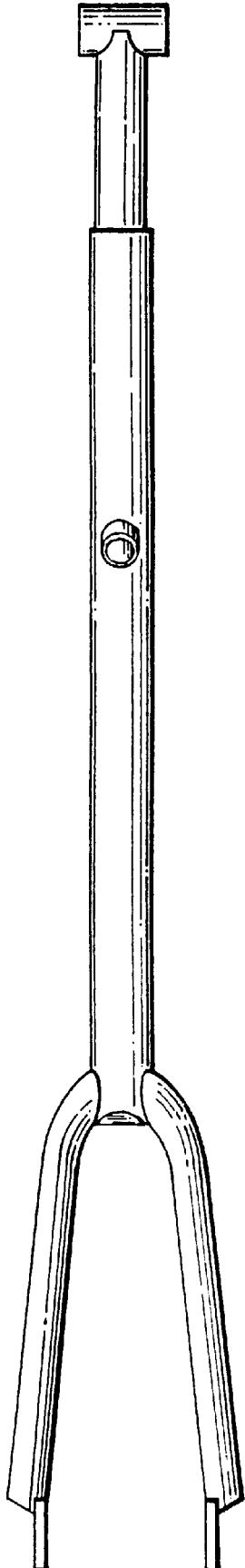

FIG. 7

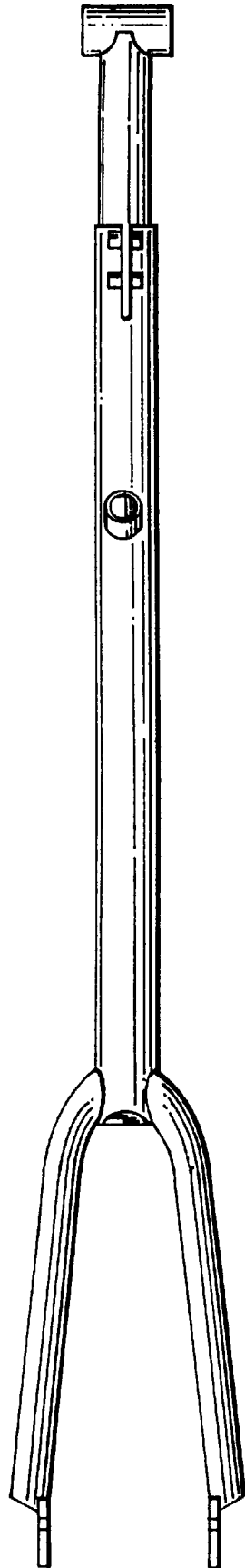

FIG. 8



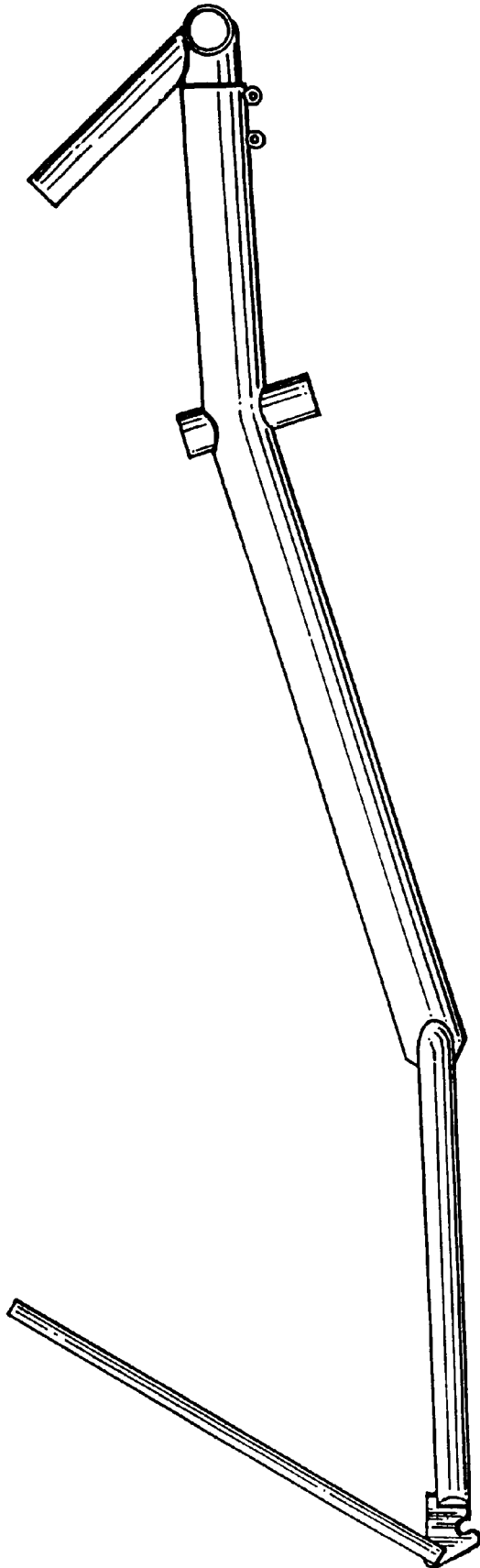

FIG. 9

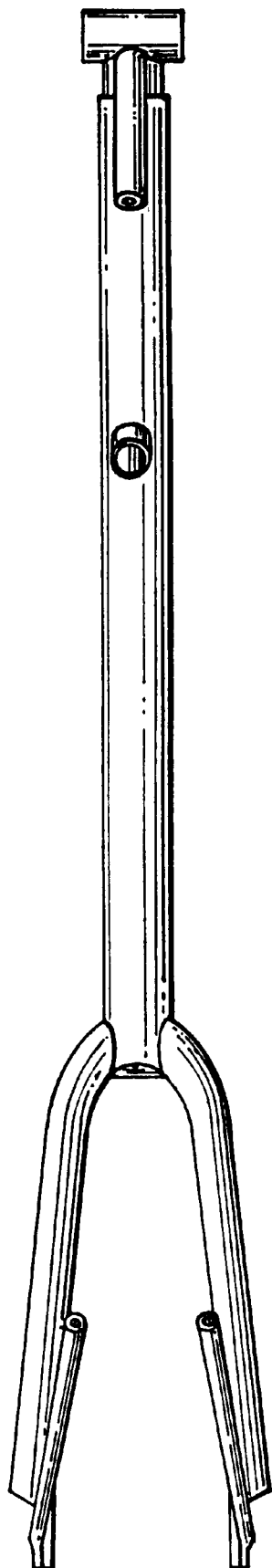

FIG. 10

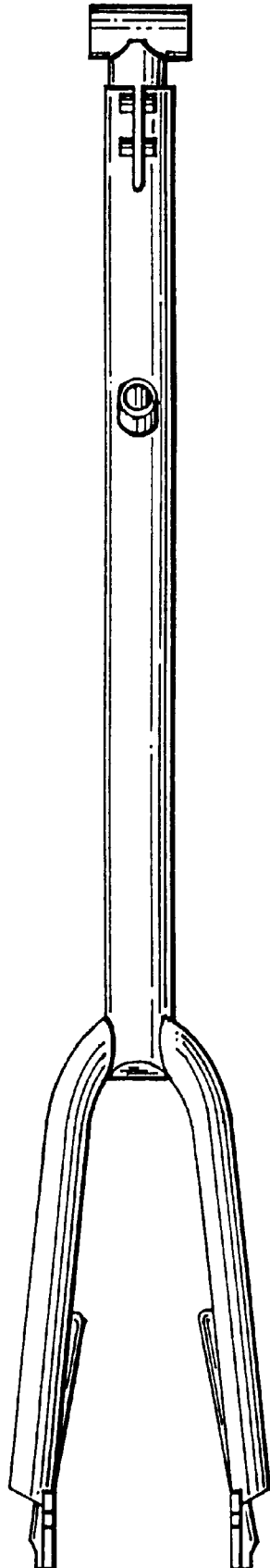

FIG. II

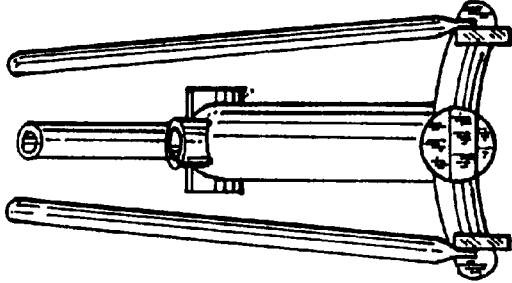

FIG. 13

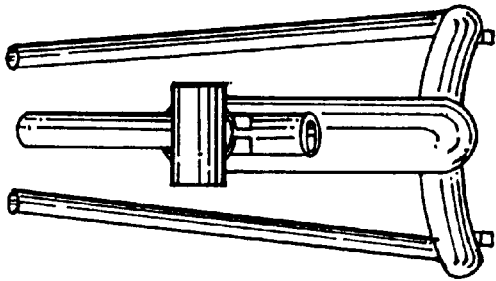

FIG. 12

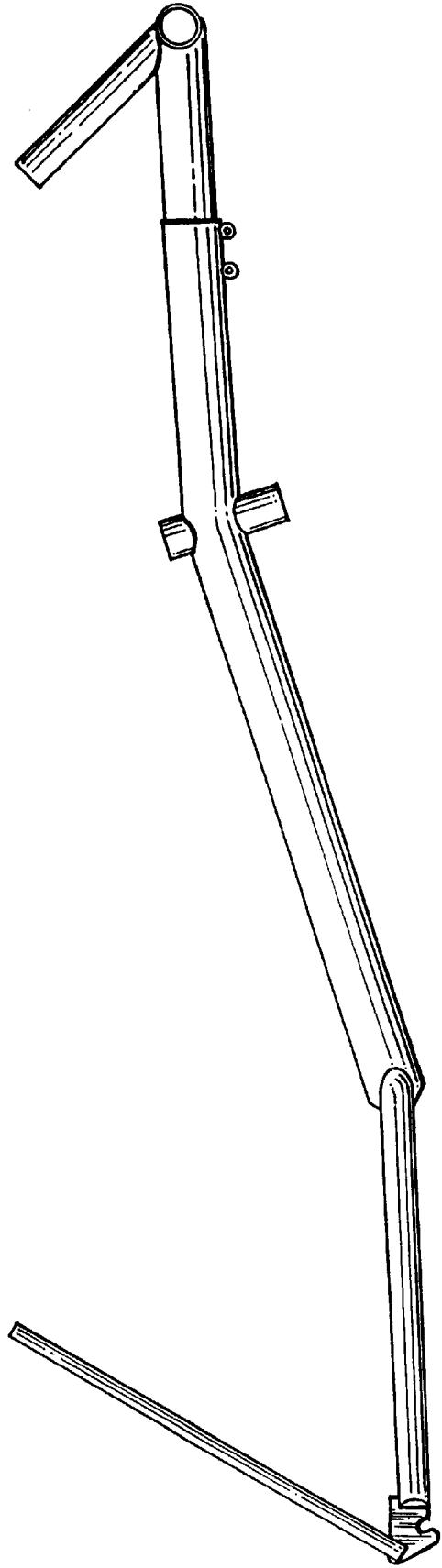

FIG. 14

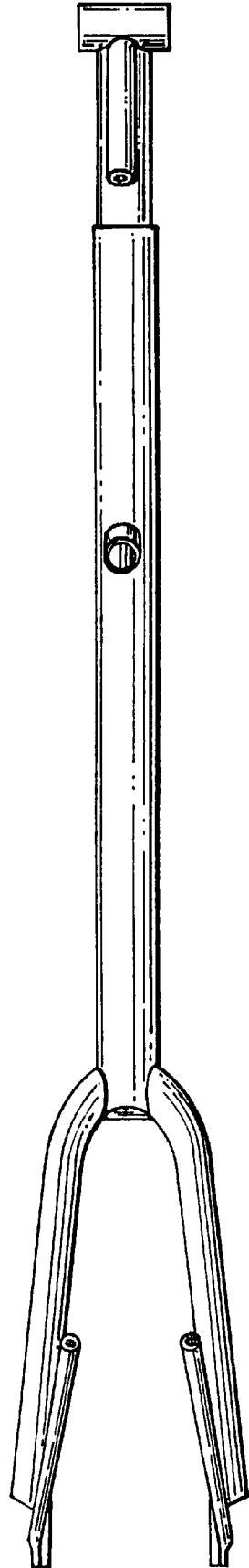

FIG. 15

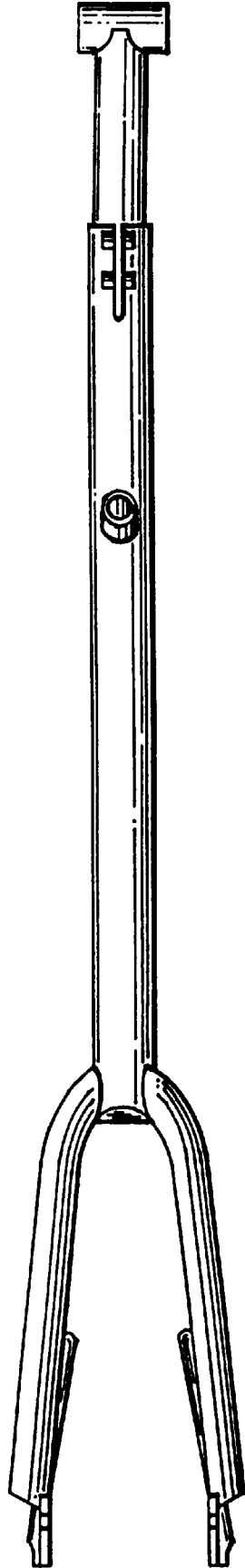

FIG. 16

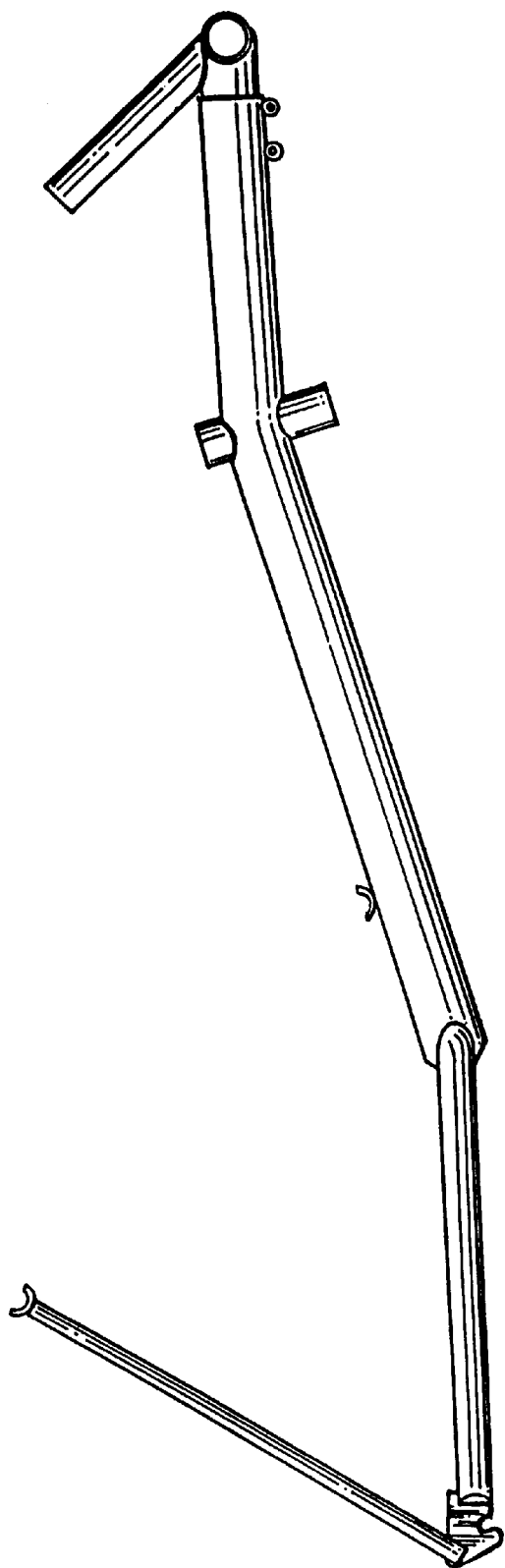

FIG. 17



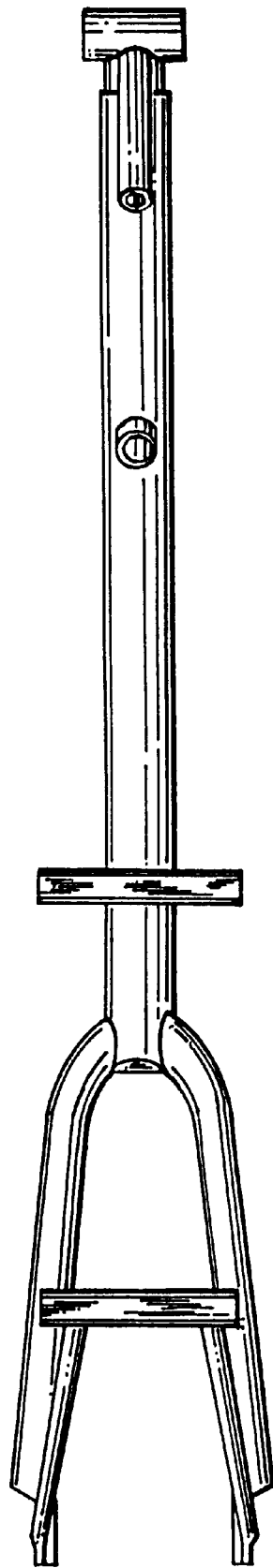

FIG. 18

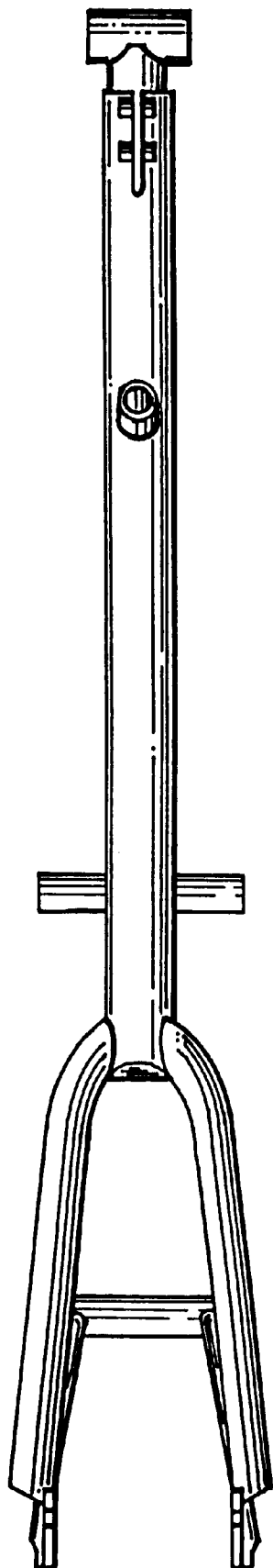

FIG. 19

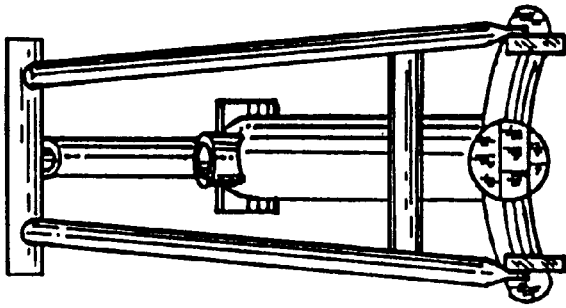

FIG. 21

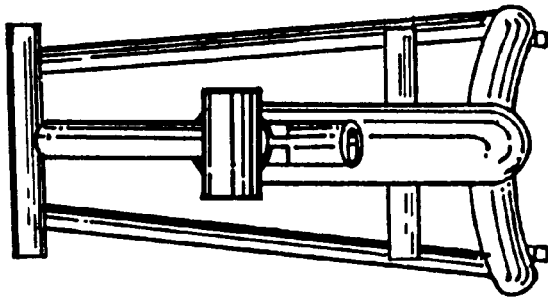

FIG. 20

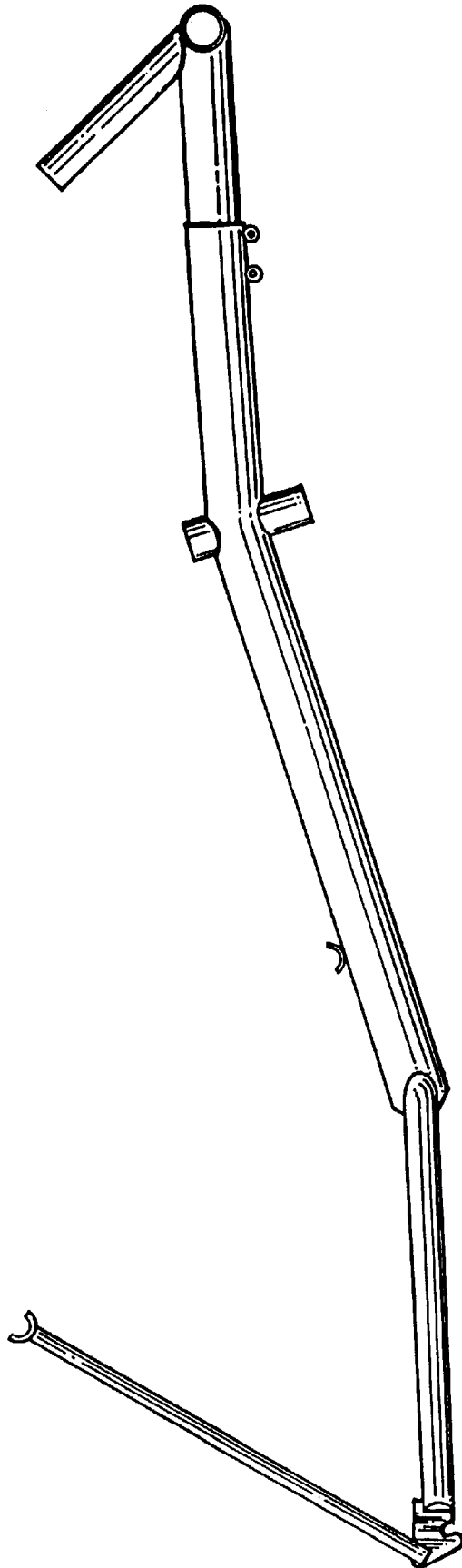

FIG. 22

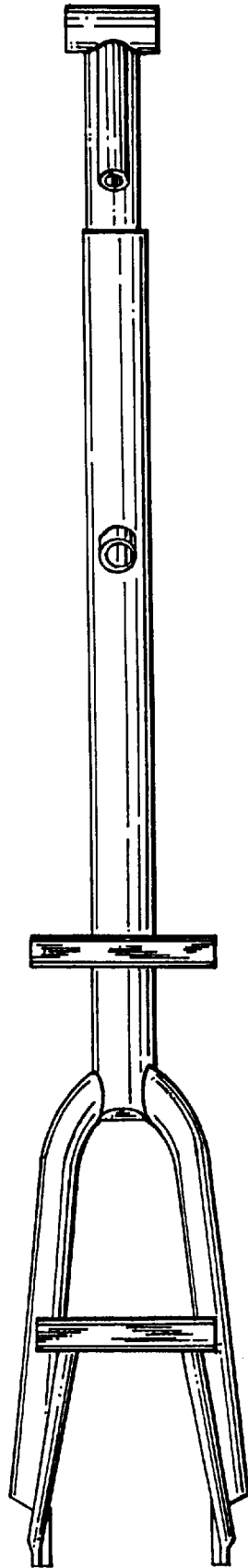

FIG. 23

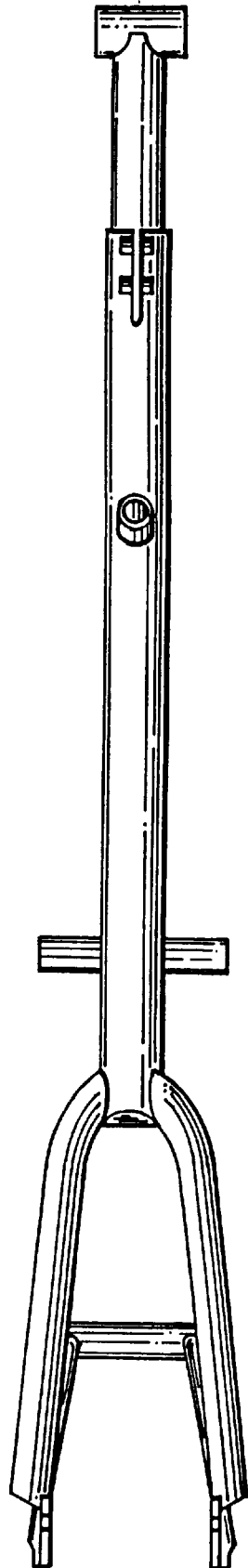

FIG. 24