



US00D435490S

United States Patent [19]

[11] Patent Number: Des. 435,490

Brummer

[45] Date of Patent: ** Dec. 26, 2000

[54] RECUMBENT BICYCLE FRAME

[76] Inventor: Timothy E. Brummer, 312 Ninth St., Lompoc, Calif. 93436

[**] Term: 14 Years

[21] Appl. No.: 29/121,192

[22] Filed: Mar. 30, 2000

Related U.S. Application Data

[62] Division of application No. 29/096,450, Nov. 12, 1998, Pat. No. Des. 428,830.

[51] LOC (7) Cl. 12-11

[52] U.S. Cl. D12/111

[58] Field of Search D12/111; 280/288.1-288.3, 280/281.1, 173.4

[56] References Cited

U.S. PATENT DOCUMENTS

D. 301,130	5/1989	Brummer	D12/111
D. 301,136	5/1989	Brummer	D12/111
D. 304,319	10/1989	Brummer	D12/111
D. 327,040	6/1992	Brummer	D12/111
D. 369,574	5/1996	Clarke	D12/111
D. 396,574	8/1998	Clarke	D12/111
D. 420,370	2/2000	Spriggs et al.	D12/111
D. 428,830	8/2000	Brummer	D12/111
5,272,928	12/1993	Young	280/288.2

OTHER PUBLICATIONS

Brochure from Advanced Transportation Products, Inc., Model R40 (Sep. 1998).

RCN (Recumbent Bicycle News), Mar. 1997, Greenspeed GBR20/26 Tourer SWB.

Photocopy of photograph of an old Vision model from 1992 to 1993.

Primary Examiner—Melody N. Brown

Attorney, Agent, or Firm—Christie, Parker & Hale, LLP

[57] CLAIM

The ornamental design for a recumbent bicycle frame, as shown and described.

DESCRIPTION

FIG. 1 is a side elevation view of a recumbent bicycle frame

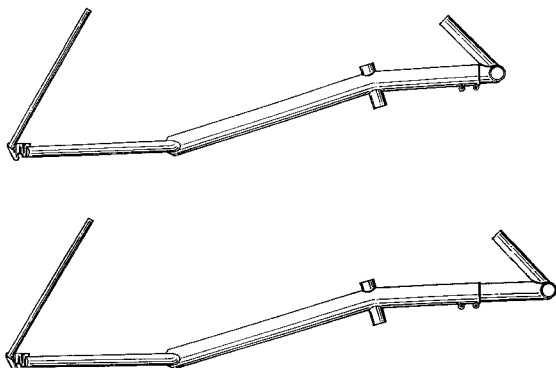

showing a first embodiment of my invention, the opposite side being a mirror image of that shown.

FIG. 2 is a top plan view of the recumbent bicycle frame of FIG. 1;

FIG. 3 is a bottom plan view of the recumbent bicycle frame of FIG. 1;

FIG. 4 is a front elevation view thereof of the recumbent bicycle frame of FIG. 1;

FIG. 5 is a rear elevation view of the recumbent bicycle frame of FIG. 1;

FIG. 6 is a side elevation view, showing a second embodiment of a recumbent bicycle frame of my invention, wherein an adjustable portion of the frame is shown in its forward most position, the opposite side being a mirror image of that shown;

FIG. 7 is a top plan view of the recumbent bicycle frame of FIG. 6;

FIG. 8 is a bottom plan view of the recumbent bicycle frame of FIG. 6;

FIG. 9 is a side elevation view of a recumbent bicycle frame showing a third embodiment of my new design, the opposite side being a mirror image of that shown;

FIG. 10 is a top plan view of the recumbent bicycle frame of FIG. 9;

FIG. 11 is a bottom plan view of the recumbent bicycle frame of FIG. 9;

FIG. 12 is a front elevation view of the recumbent bicycle frame of FIG. 9;

FIG. 13 is a rear elevation view of the recumbent bicycle frame of FIG. 9;

FIG. 14 is a side elevation view, showing a fourth embodiment of the recumbent bicycle frame of my invention, wherein an adjustable portion of the frame is shown in its forward most position, the opposite side being a mirror image of that shown;

FIG. 15 is a top plan view of the recumbent bicycle frame of FIG. 14; and,

FIG. 16 is a bottom plan view of the recumbent bicycle frame of FIG. 14.

1 Claim, 14 Drawing Sheets

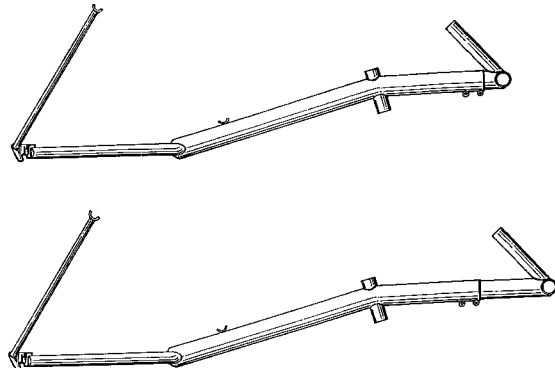

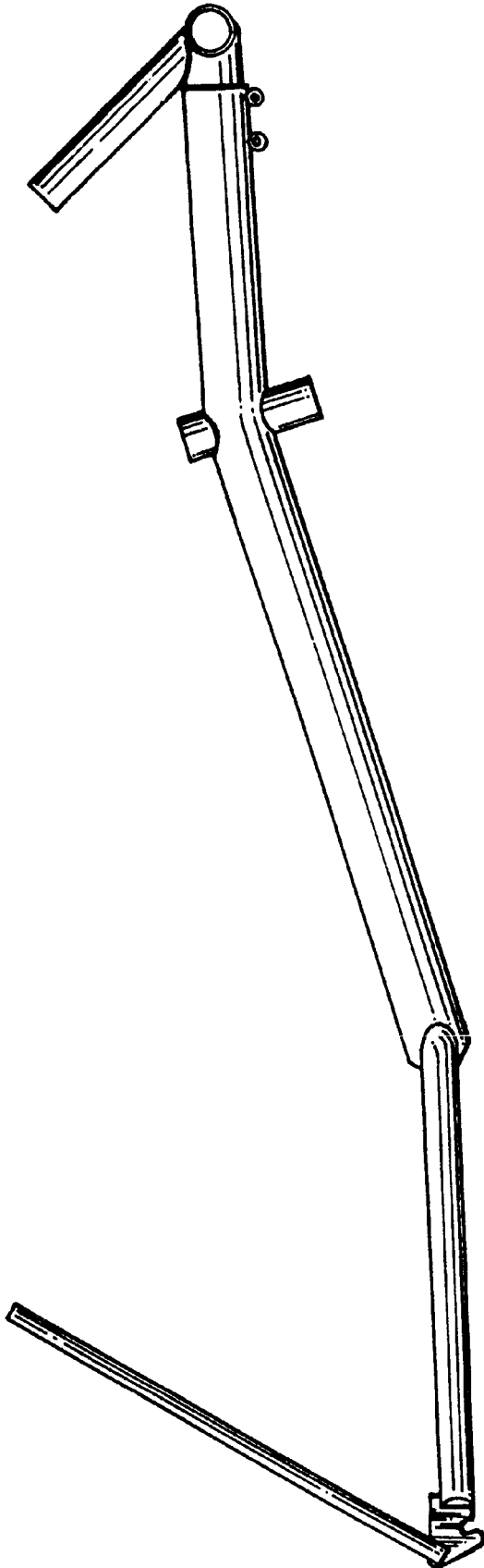

FIG. 1

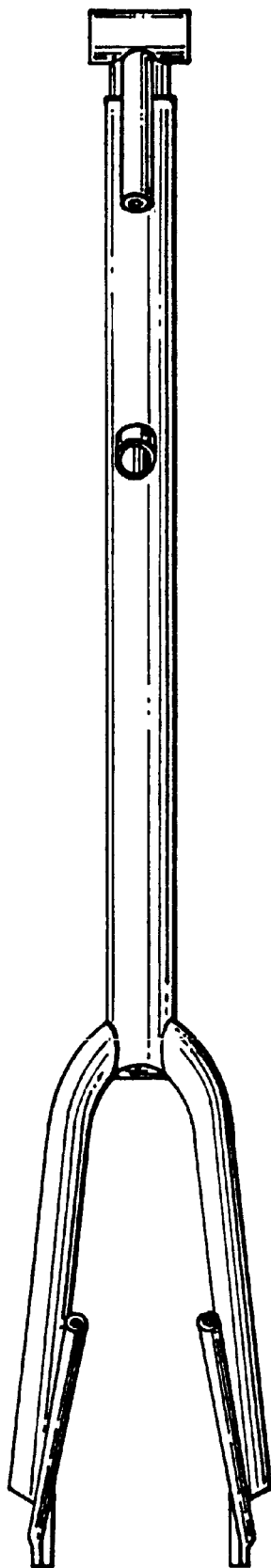

FIG. 2

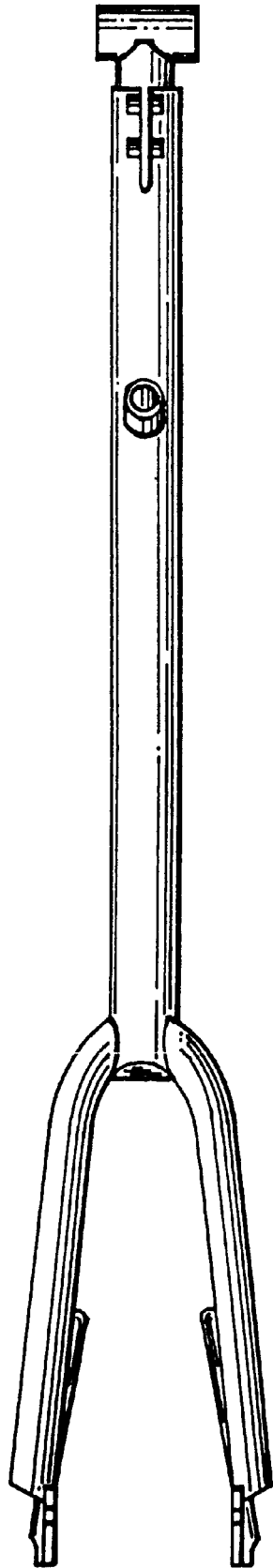

FIG. 3

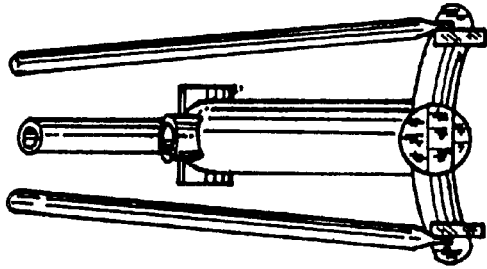

FIG. 5

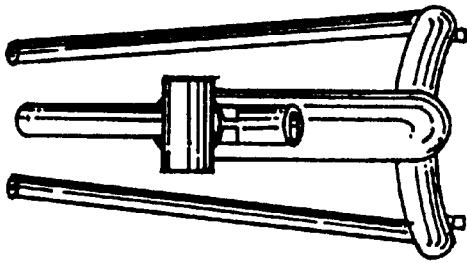

FIG. 4

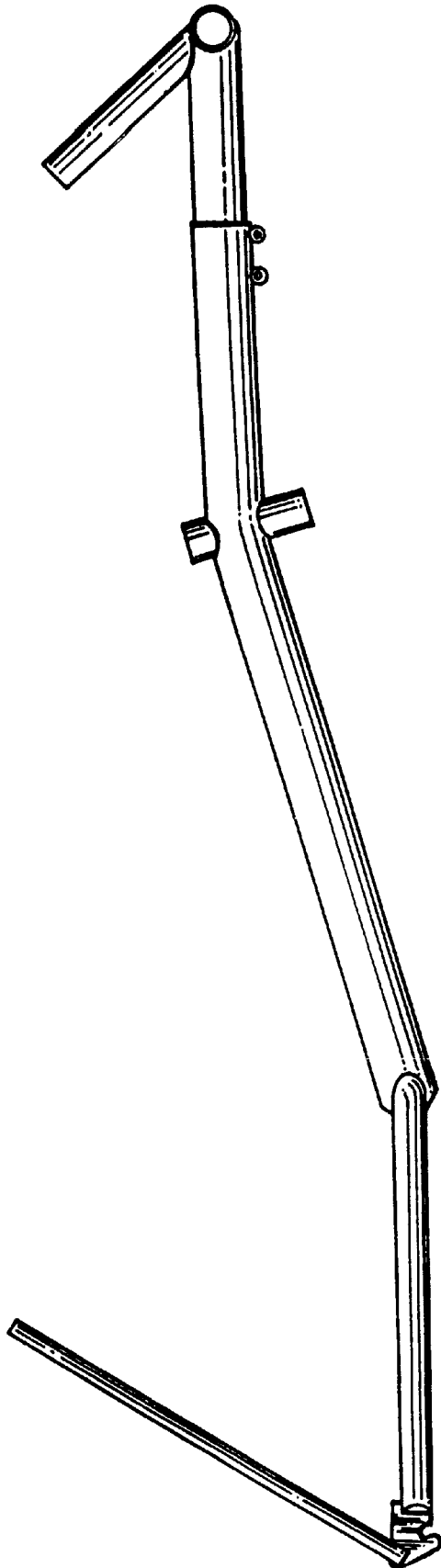

FIG. 6

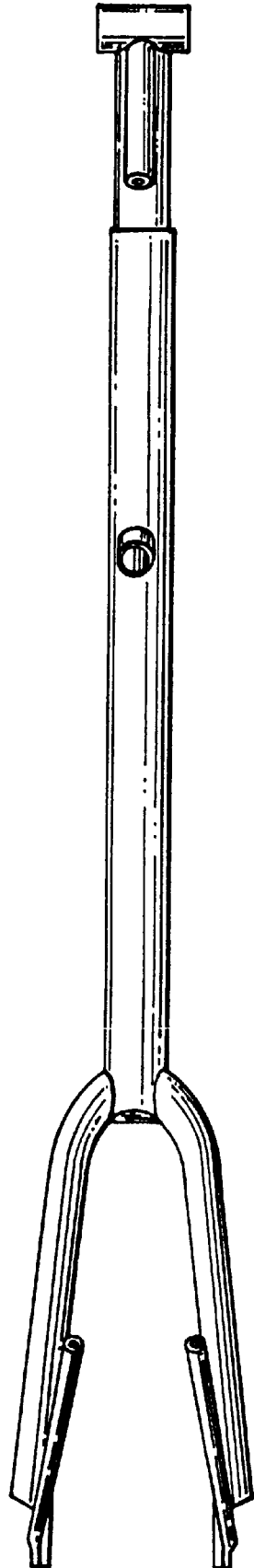

FIG. 7

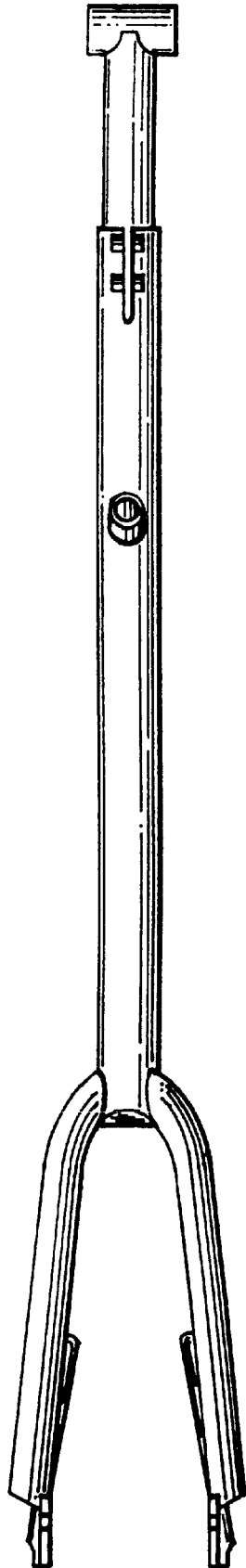

FIG. 8

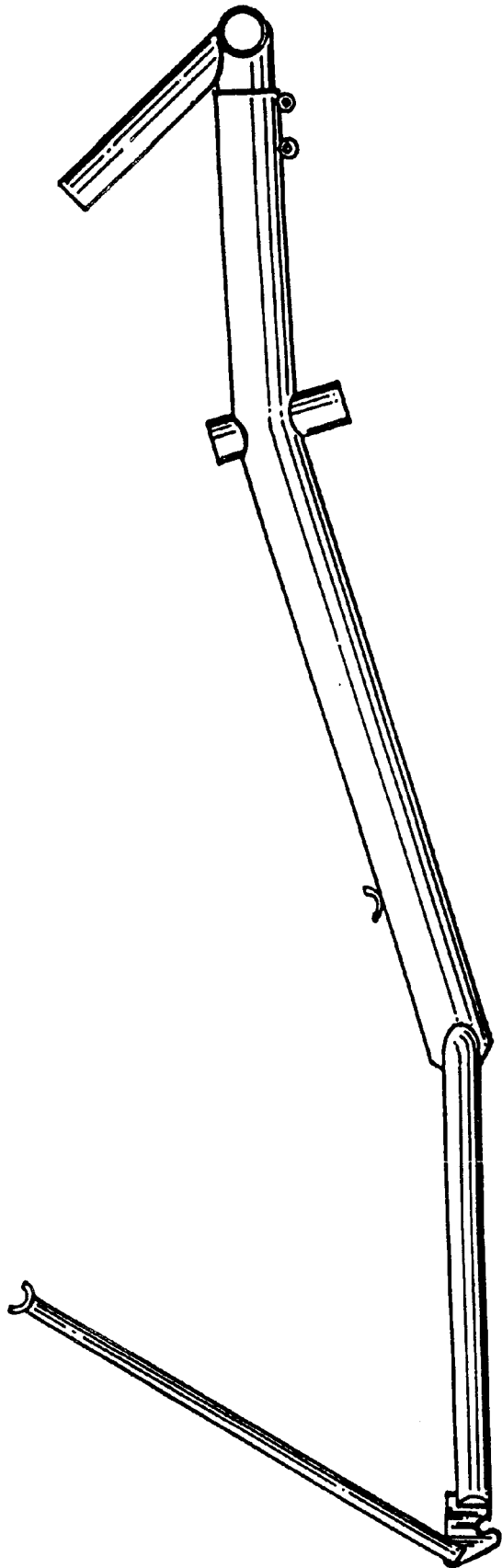

FIG. 9

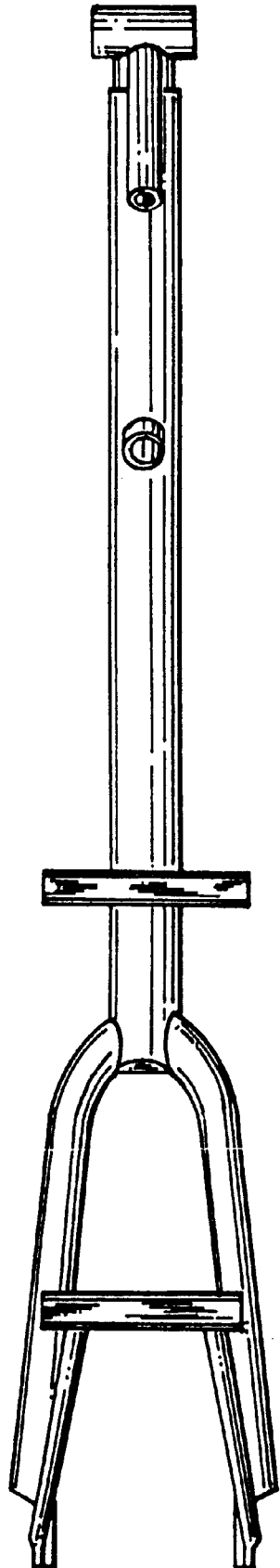

FIG. 10

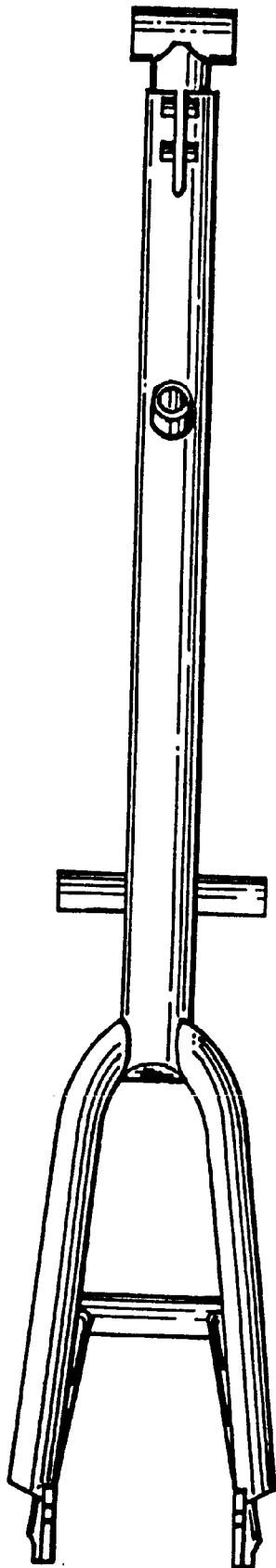

FIG. II

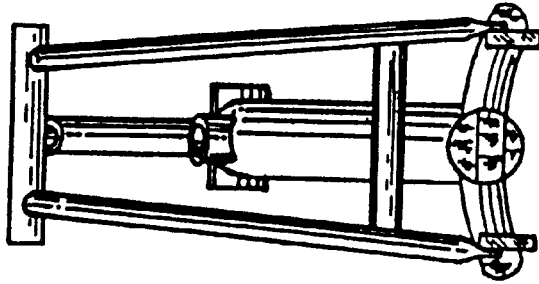

FIG. 13

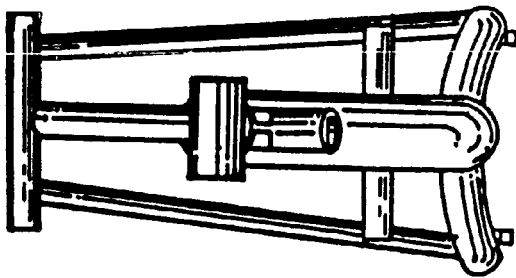

FIG. 12

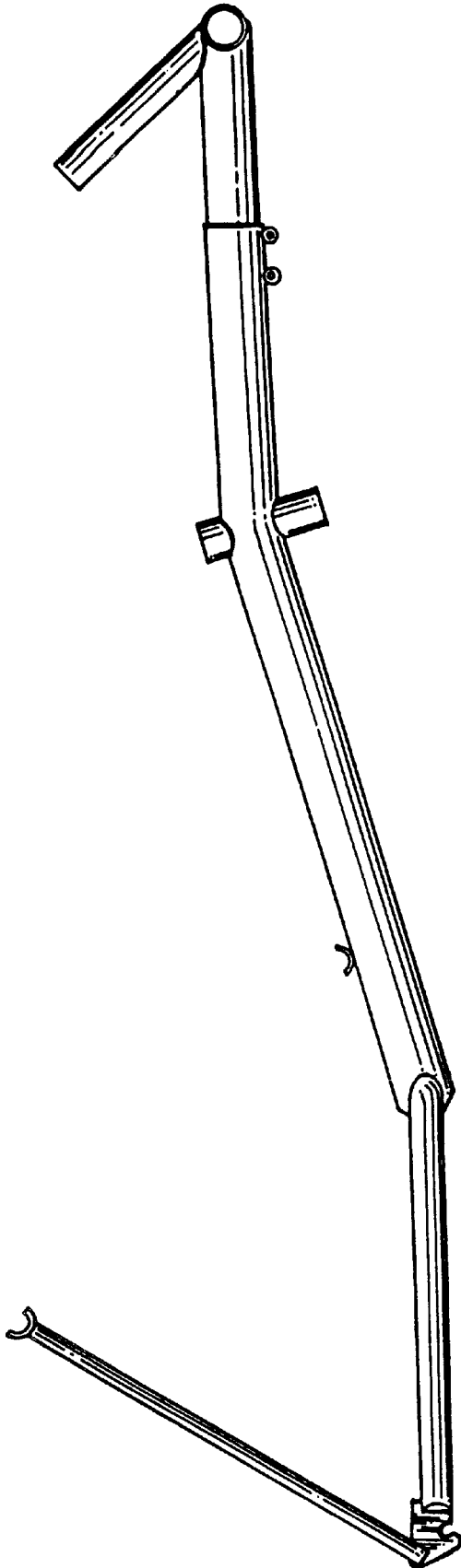

FIG. 14

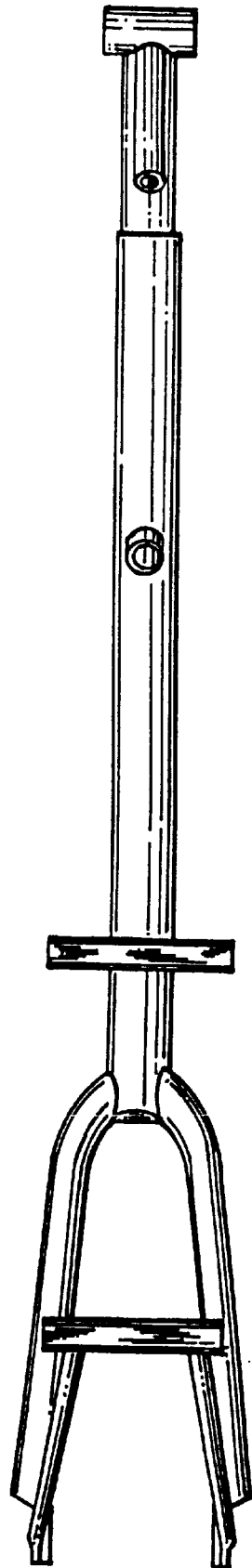

FIG.15

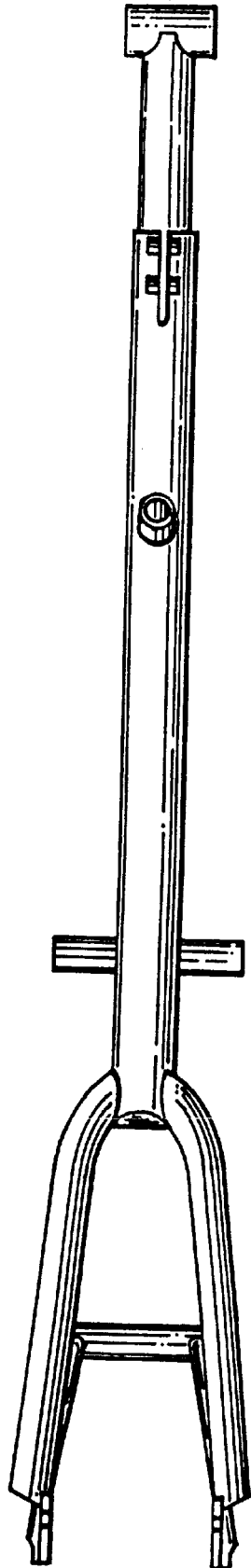

FIG. 16