



US00D665708S

(12) **United States Design Patent**
Uimonen

(10) **Patent No.:** **US D665,708 S**

(45) **Date of Patent:** **** Aug. 21, 2012**

- (54) **FOLDABLE BICYCLE FRAME**
- (75) Inventor: **Joakim Uimonen**, San Chung (TW)
- (73) Assignee: **Mobility Holdings, Limited**, Wanchai (HK)
- (**) Term: **14 Years**
- (21) Appl. No.: **29/416,153**
- (22) Filed: **Mar. 19, 2012**

(74) *Attorney, Agent, or Firm* — Muncy, Geissler, Olds & Lowe, PLLC

(57) **CLAIM**
The ornamental design for a foldable bicycle frame, as shown and described.

Related U.S. Application Data

- (62) Division of application No. 29/390,630, filed on Apr. 27, 2011.
 - (51) **LOC (9) Cl.** **12-11**
 - (52) **U.S. Cl.** **D12/111**
 - (58) **Field of Classification Search** D12/111, D12/117; 280/274–280, 281.1, 283–288, 280/288.1–288.4
- See application file for complete search history.

DESCRIPTION

FIG. 1 is a perspective view of a foldable bicycle frame showing my new design;
 FIG. 2 is a front elevational view thereof;
 FIG. 3 is a rear elevational view thereof;
 FIG. 4 is a left side view thereof;
 FIG. 5 is a right side view thereof;
 FIG. 6 is a top plan view thereof;
 FIG. 7 is a bottom plan view thereof;
 FIG. 8 is a perspective view showing the foldable bicycle frame of FIG. 1 being assembled on a foldable bicycle;
 FIG. 9 is a perspective view of a foldable bicycle frame showing another embodiment of my design;
 FIG. 10 is a front elevational view thereof;
 FIG. 11 is a rear elevational view thereof;
 FIG. 12 is a left side view thereof;
 FIG. 13 is a right side view thereof;
 FIG. 14 is a top plan view thereof;
 FIG. 15 is a bottom plan view thereof; and,
 FIG. 16 is a perspective view showing the foldable bicycle frame of FIG. 9 being assembled on a foldable bicycle.
 The broken line showing of the foldable bicycle in FIGS. 8 and 16 is for the purpose of illustrating environmental structure only and forms no part of the claimed design.

References Cited

U.S. PATENT DOCUMENTS

3,722,913	A	3/1973	Housayama
D235,249	S	6/1975	Kitsuda
4,541,648	A	9/1985	Takamiya et al.
7,393,125	B1	7/2008	Lai
D586,702	S	2/2009	Morris
D610,047	S	2/2010	Uimonen
D622,638	S	8/2010	Uimonen
D632,615	S	2/2011	Uimonen

Primary Examiner — Susan M Lee
Assistant Examiner — Linda G. Brooks

1 Claim, 12 Drawing Sheets

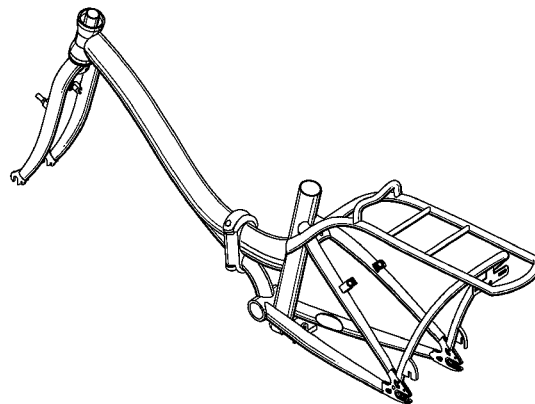
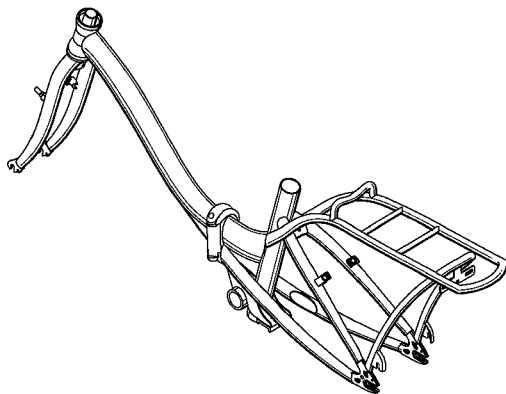

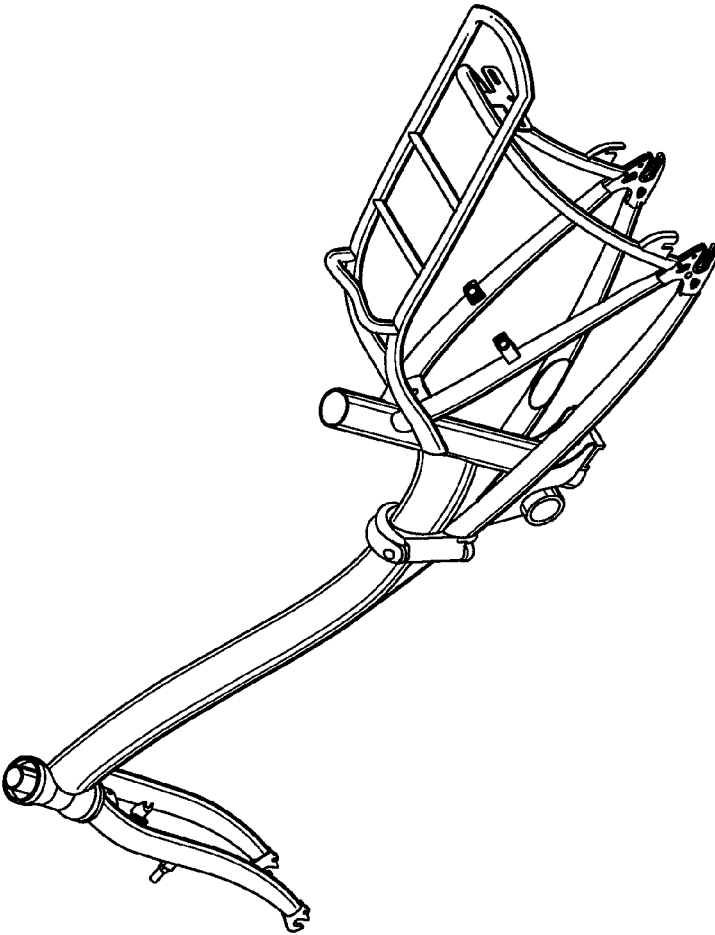

FIG. 1

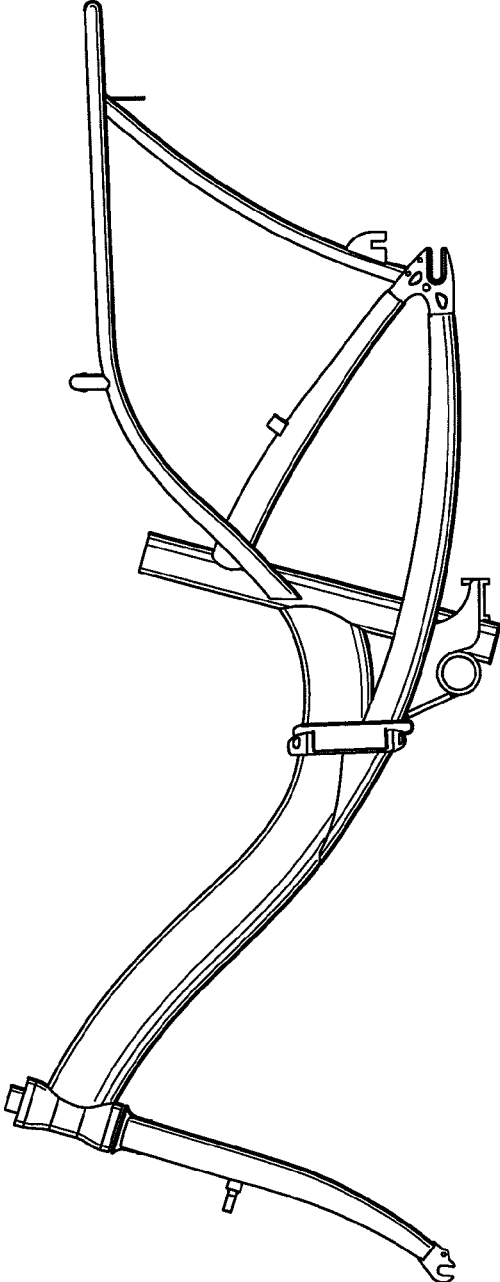

FIG. 2

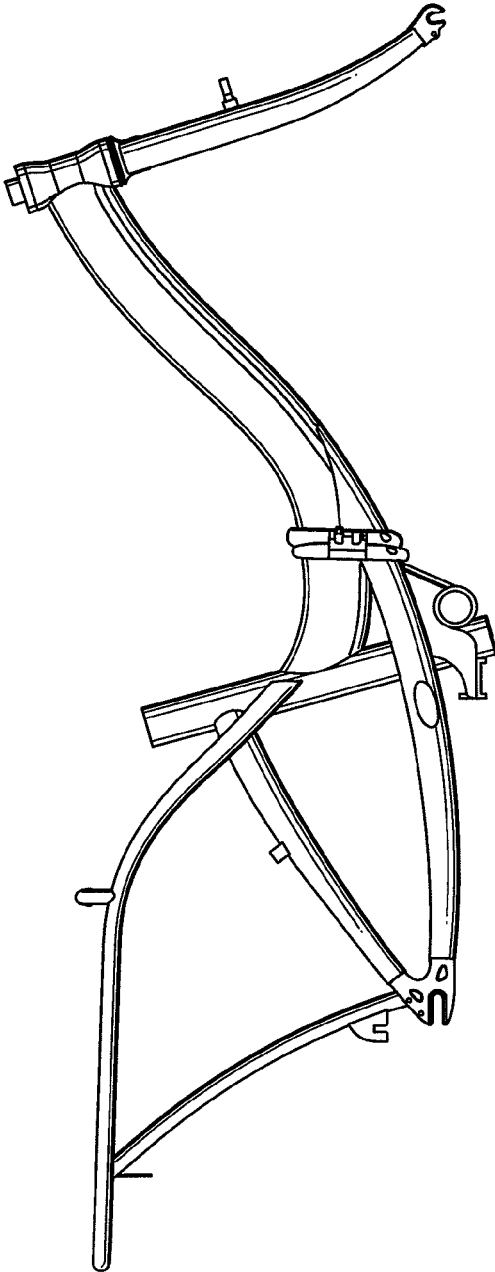

FIG. 3

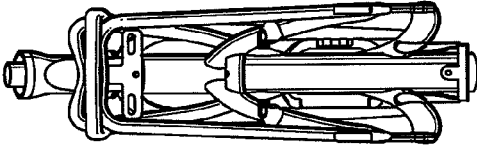

FIG. 5

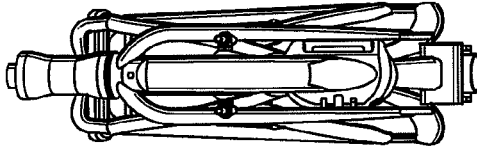

FIG. 4

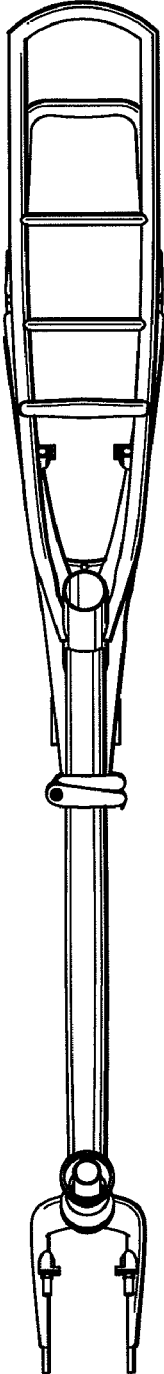

FIG. 6

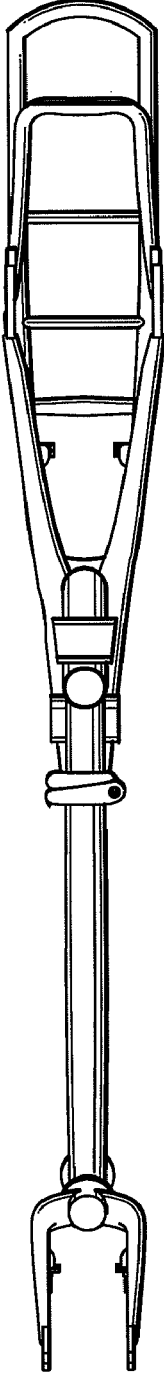

FIG. 7

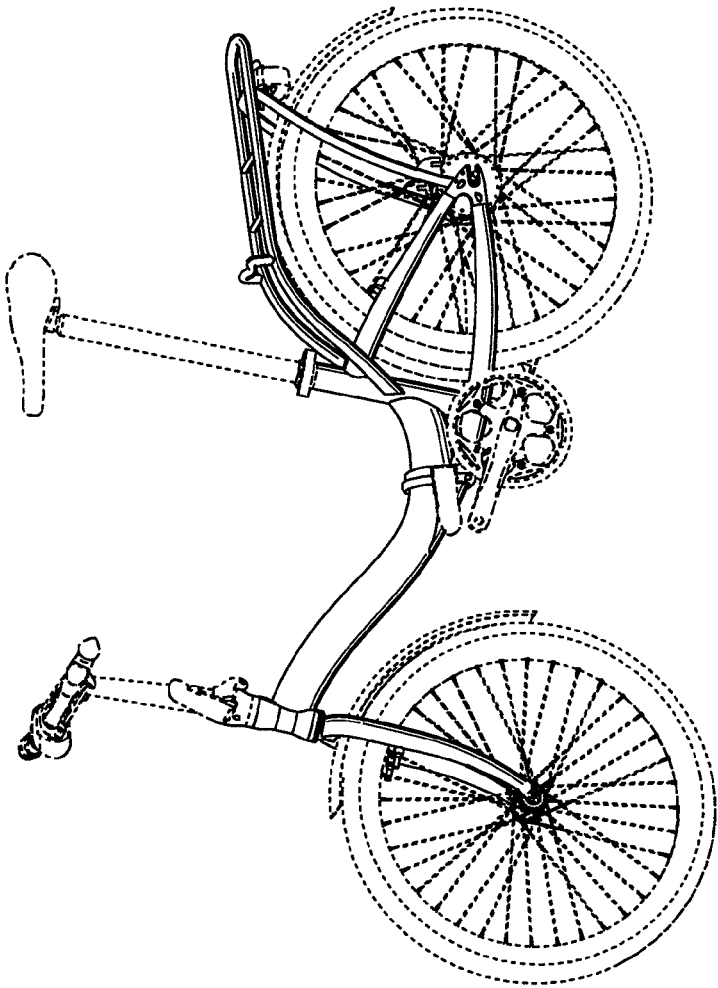

FIG. 8

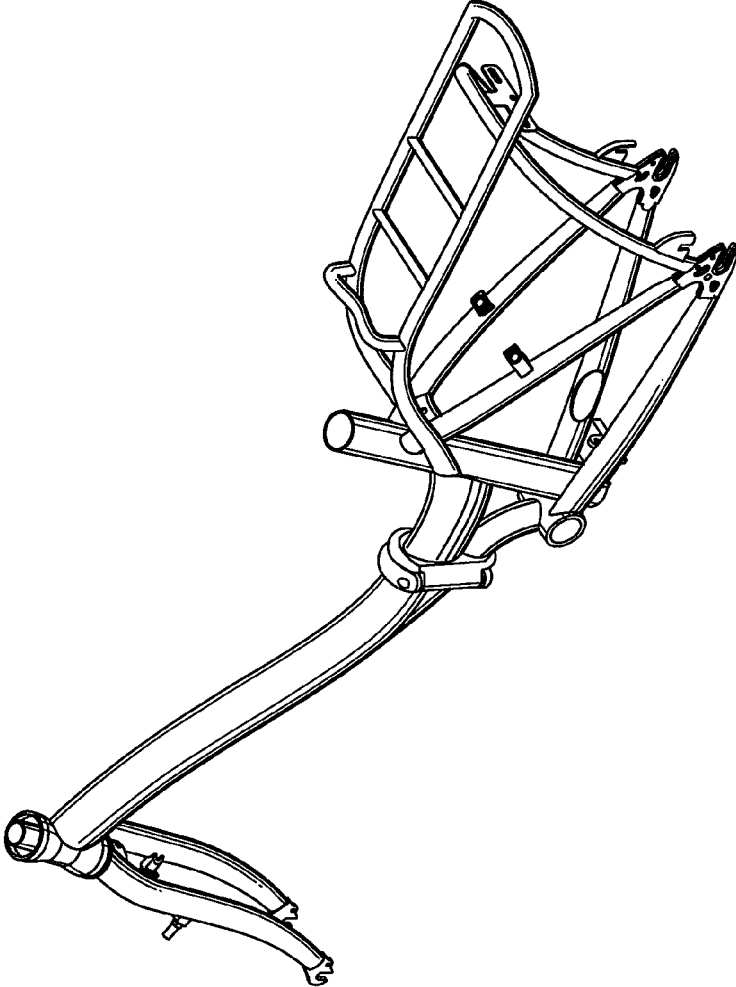

FIG. 9

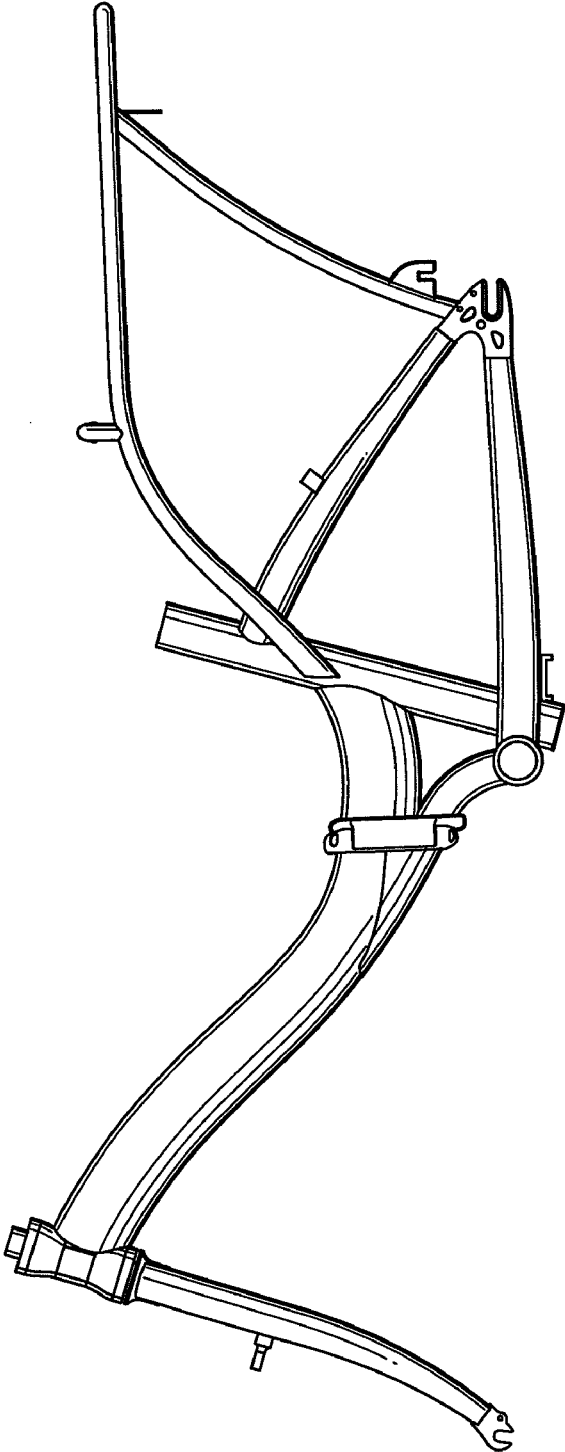

FIG. 10

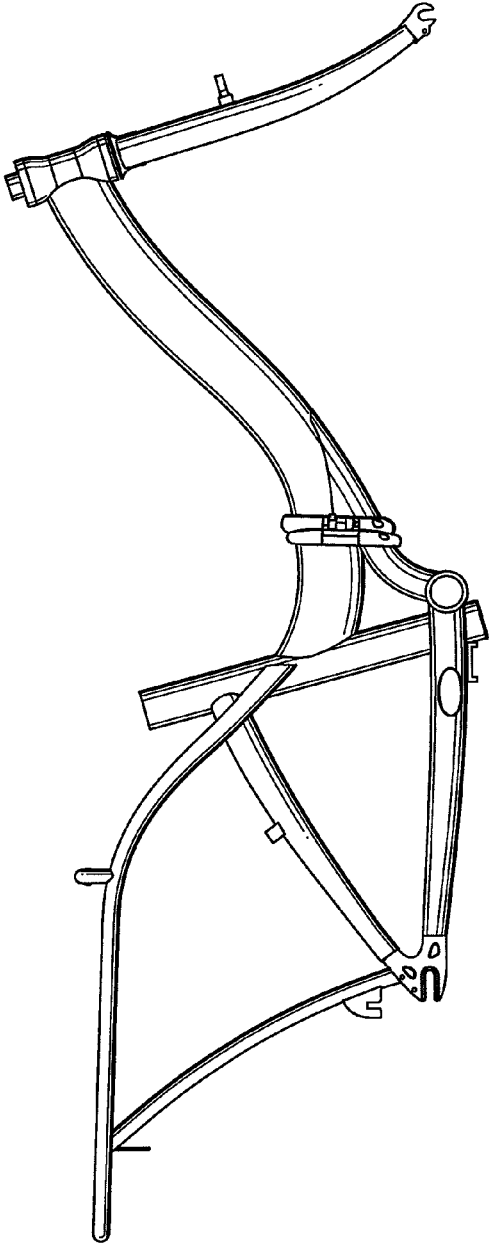

FIG. 11

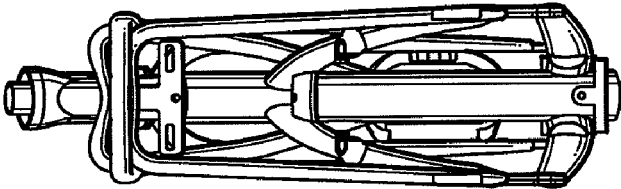

FIG. 13

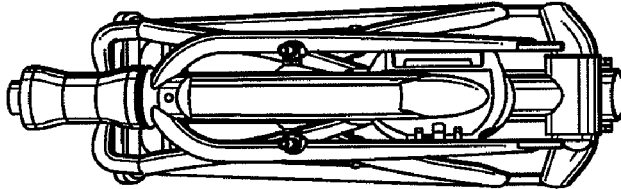

FIG. 12

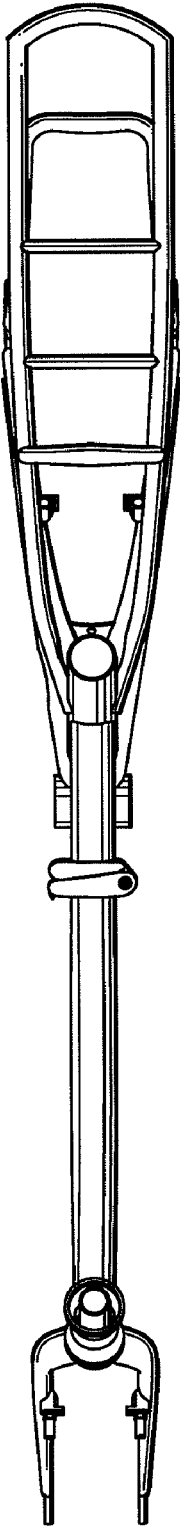

FIG. 14

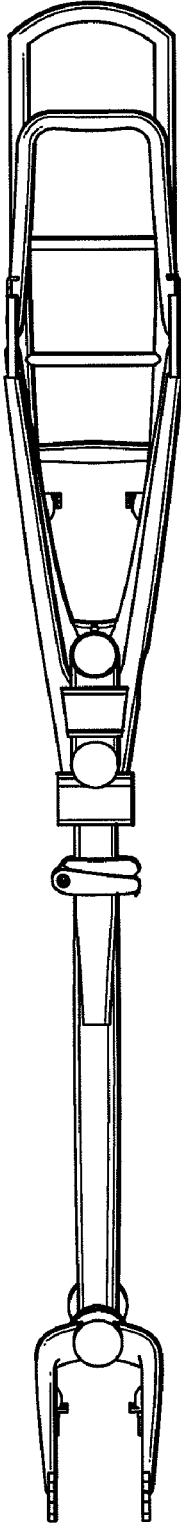

FIG. 15

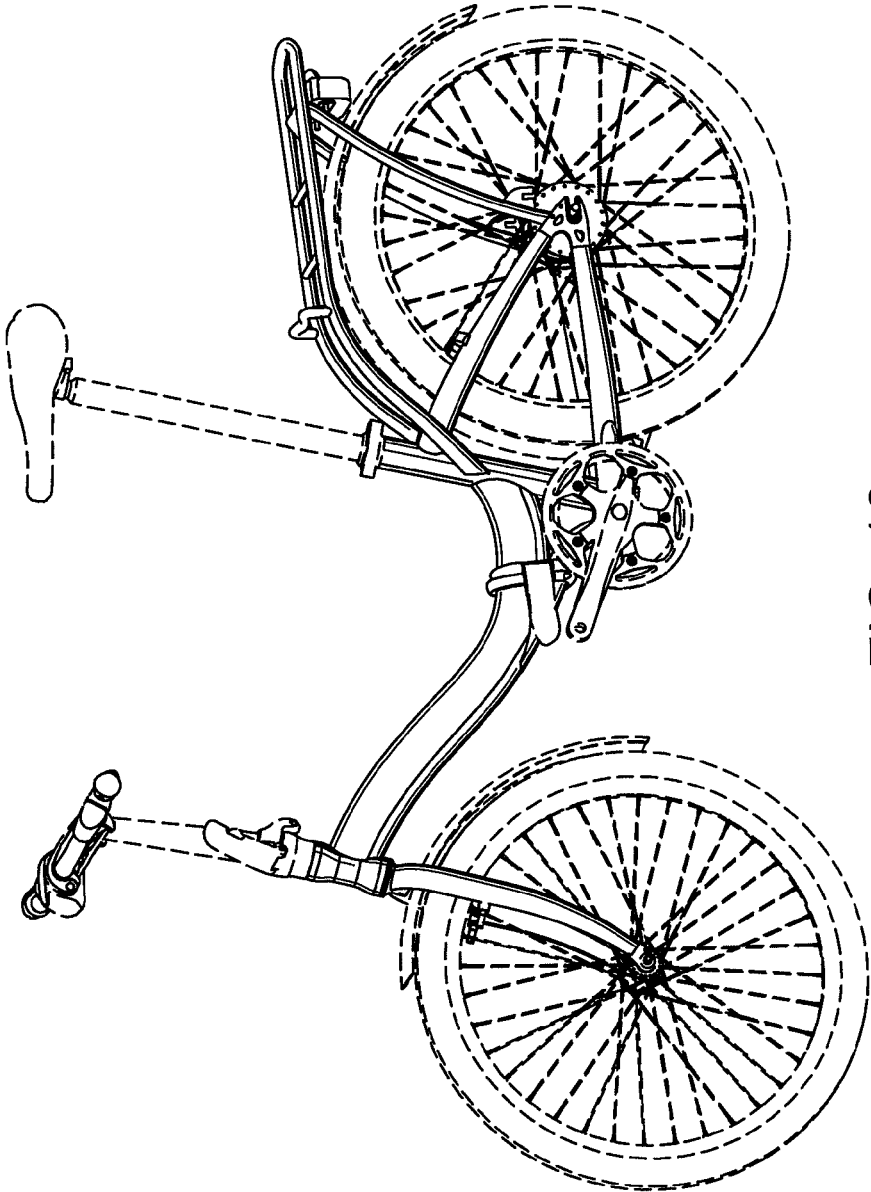

FIG. 16